













Arms & Accessories



38mm x 1m Stainless Steel Flexible Arm Kit

	<p>Capture Apparatus Included</p> <ul style="list-style-type: none"> 1 x 38mm x 1m stainless steel flexible arm with fixed pen nib nozzle 1 x Support collar and valve 1 x Screwed bench bracket 1 x 51mm x 2m flexible hose with 2 connecting cuffs <p>Replacement parts available if required.</p>		<p>Capture Apparatus Included</p> <ul style="list-style-type: none"> 1 x 38mm x 1m stainless steel flexible arm (includes 1 x Support collar and valve) 1 x Clamped bench bracket 1 x Pen-nib nozzle (38mm ID) 1 x Conical cowl (95mm ID) 1 x 51mm x 2m flexible hose with 2 connecting cuffs <p>Replacement parts available if required.</p>
<p>Code: 100294</p>		<p>Code: 100295</p>	



38mm Spares and Accessories

Capture Apparatus (Optional)			
	<p>Clear hood cowl (265 x 310mm) Code: 840160</p>		<p>Pen Nib Nozzle (38mm ID) Code: 840170</p>
	<p>Delta cowl (192 x 5mm inlet) Code: 840182</p>		<p>Conical Cowl (95mm ID) Code: 840190</p>
Fittings (Optional)			
	<p>Screwed bench bracket Code: 840200</p>		<p>Clamped bench bracket Code: 120180</p>
	<p>Wall bracket Code: 840210</p>		<p>Bench support collar and valve Code: 840047</p>

Replacement 38mm x 1m Stainless Steel Flexible Arm

	<p>Build</p> <p>This is a high quality stainless steel replacement arm to fit plastic push fit system arms.</p> <ul style="list-style-type: none"> 1 x 38mm x 1m stainless steel flexible arm 1 x Pen-nib nozzle (38mm ID) or 1 x Conical cowl (38mm ID) 1 x Tapered fitting 	
<p>Pen Nib Type Code: 120143</p>		<p>Conical Cowl Type Code: 120144</p>

Plenum Cows

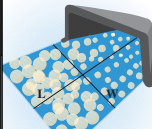
	<p>Plenum cowl Anti static polycarbonate (black) Includes 57mm airflow valve Code: 120703</p>			<p>Plenum cowl Anti static polycarbonate (clear) Includes 57mm airflow valve Code: 120704</p> <p>Max W x L 300 x 400mm</p>
--	--	---	---	--

Connection kits with 51mm cuffs are suitable for 57mm valves